



PROMOZIONE 2026

Valida fino al 31 LUGLIO

WINCUT

WINTURN

WINDRILL

WINMILL

WINSFEED
ADVANCED MACHINING

WIN SFEED
ADVANCED MACHINING

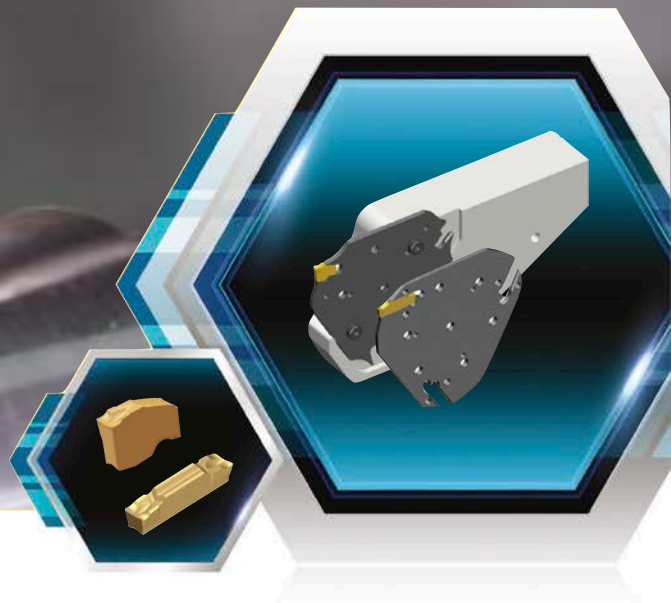
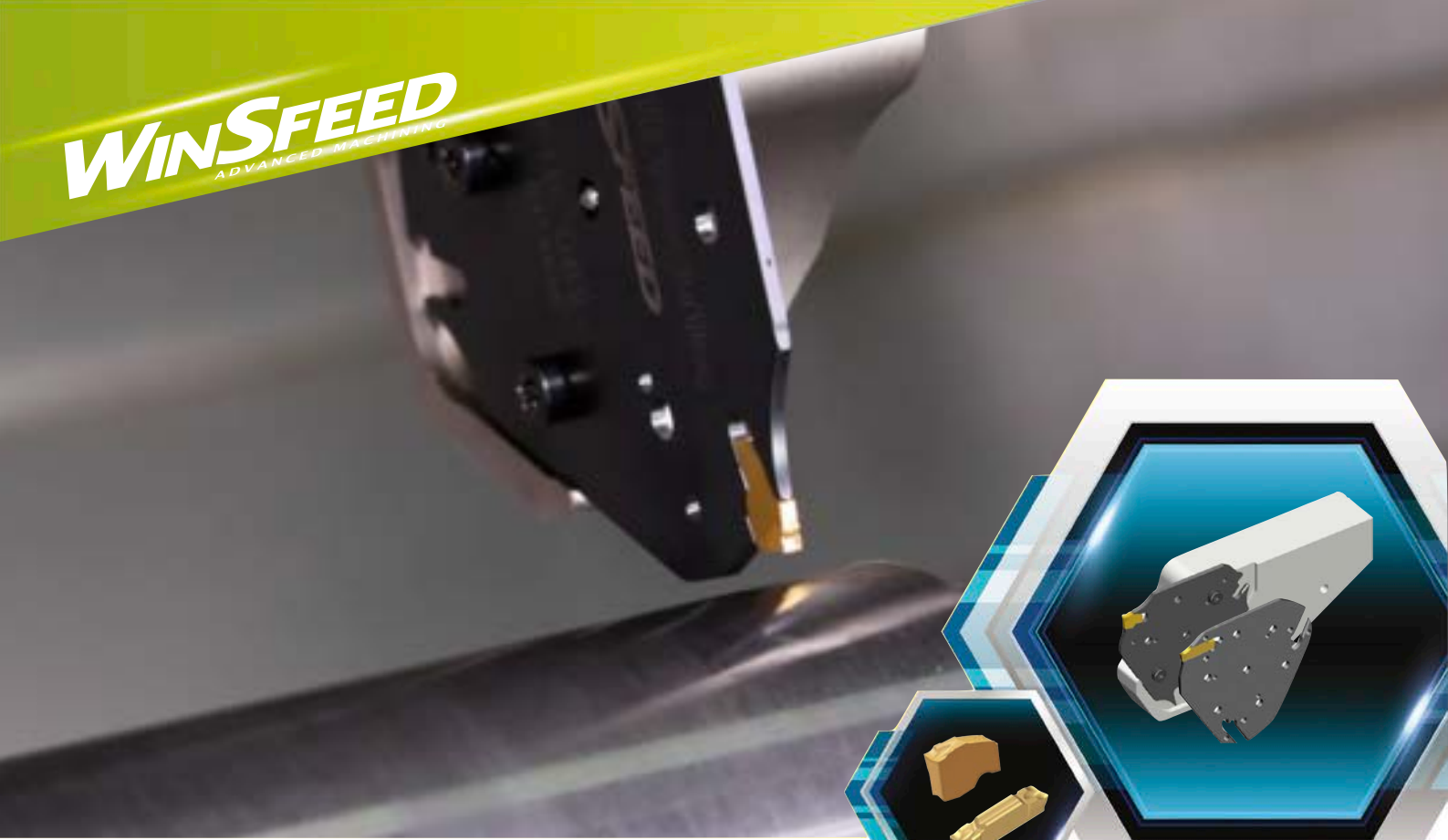

WINCUT
ADVANCED PARTING

Nuovo inserto ad alta rigidità di bloccaggio per troncatura e scanalatura con adattatore unico

Acquistando **10** inserti e **1** lama ricevi un portalama con **extra 50%** di sconto

Acquistando **20** inserti ricevi una lama con **extra 80%** di sconto

Lama: SFTB , TGTB
Portalama: THTBR/L-TB
Inserti: SFC, SFJ, TD_, TS_

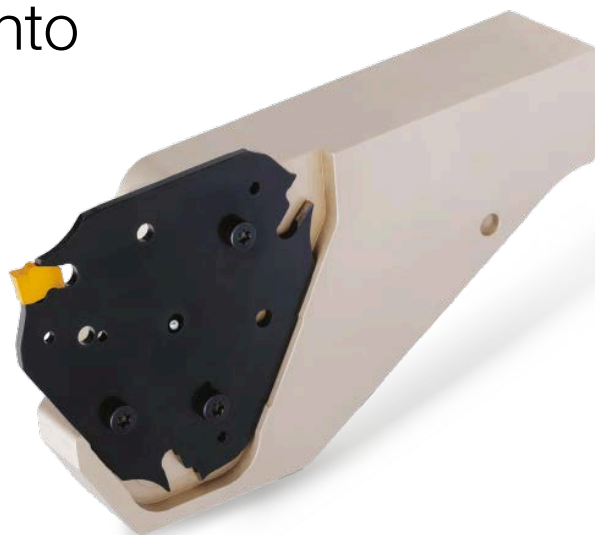

WINSPEED
ADVANCED MACHINING

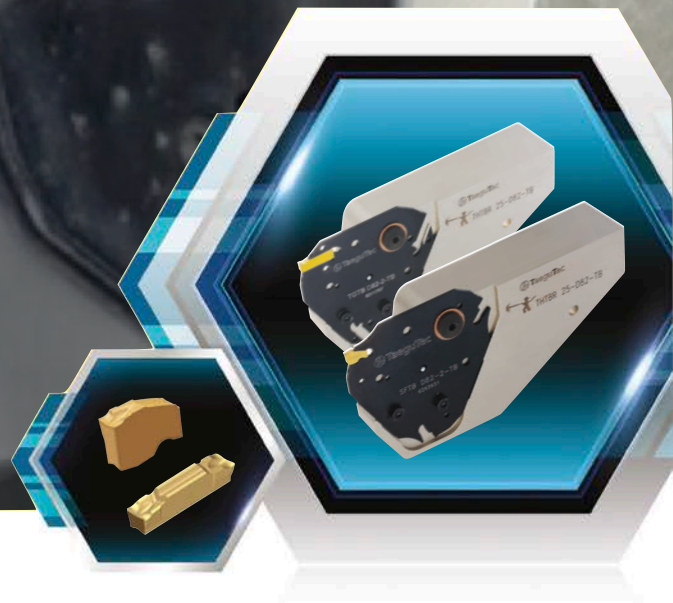

WINCUT
ADVANCED PARTING

Nuovo inserto ad alta rigidità di bloccaggio per troncatura e scanalatura con adattatore unico

Acquistando **20** inserti e **1** lama ricevi un portalama con **extra 50%** di sconto

Acquistando **20** inserti ricevi una lama con **extra 80%** di sconto

Lama: SFTB-TB, TGTB-TB
Portalama: THTBR/L-TB
Inserti: SFC, SFJ, TD_, TS_

COOLBURST
PREFORMED COOLANT



WIN SPEED
ADVANCED MACHINING



WINGROOVE

Mini inserto per la scanalatura interna in piccoli diametri

Acquistando **10** inserti ricevi un utensile **TMHR/L** in acciaio con **extra 80%** di sconto

Acquistando **20** inserti ricevi un utensile **TMHR/L-C** in metallo duro con **extra 80%** di sconto

Utensile: TMHR/L, TMHR/L-C
Inserti: TMIR/L



WIN SPEED
ADVANCED MACHINING



WIN TURN
ADVANCED MACHINING

Inserto con 6 taglienti per tornitura multidirezionale

Acquistando **10** inserti ricevi un
utensile con **extra 50%** di sconto

Utensile: TTQNR/L*
Inserti: TNMV

*Esclusa linea Cool Burst (-TB)

 **TaeguTec**
Member IMC Group



WIN SPEED
ADVANCED MACHINING

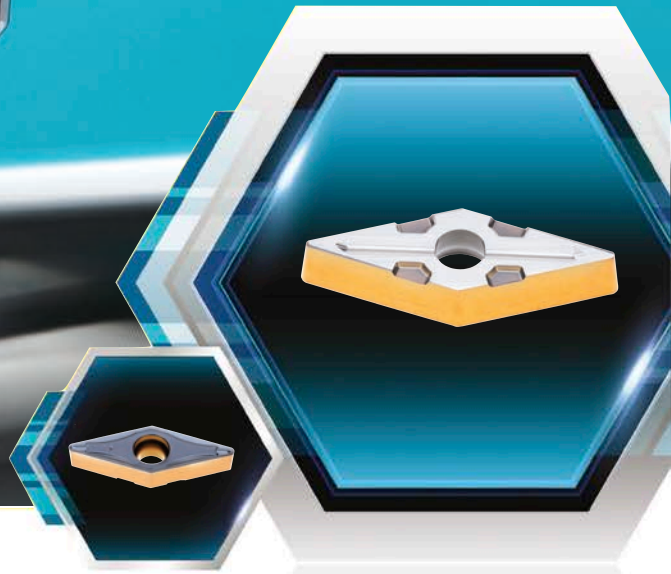

MULTI LTURN

SAFE TURNING

Utensile e inserto VBMX dal rigido bloccaggio

Acquistando **30** inserti ricevi un
utensile con **extra 60%** di sconto

Utensile: LVJBL/R
Inserti: VBMX

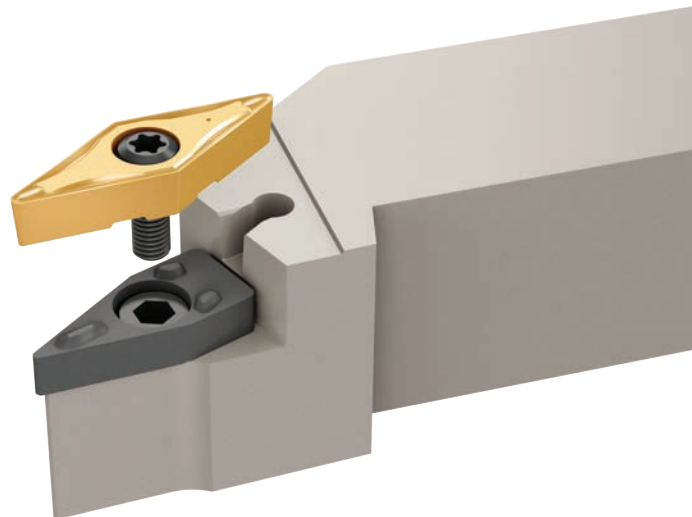

WINSPEED
ADVANCED MACHINING



WINDRILL
ADVANCED MACHINING

Punta a cuspidi di piccoli diametri

Acquistando **6** cuspidi ricevi un corpo punta **extra 40%** di sconto

Corpo punta: TCD 3D/5D*
Cuspidi: TDC 040-059P



TAEGUTEC
SPEEDTEC
HIGH SPEED & FEED LINES

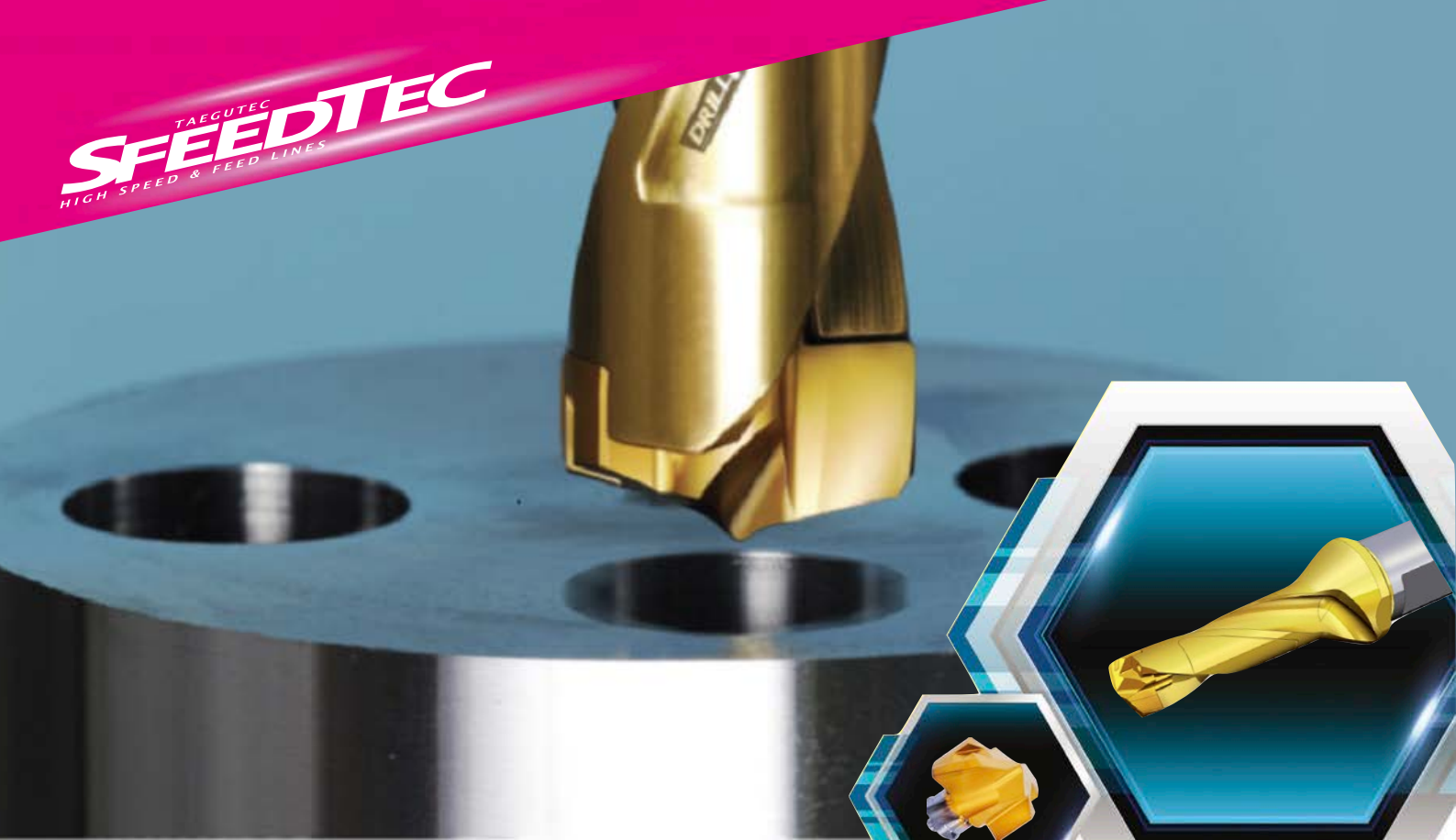

DRILL RUSH

RUSH 2 FLUTE

**Punta a cuspidi intercambiabili per un
ampia gamma di applicazioni**

Acquistando **6** cuspidi ricevi un corpo
punta **extra 40%** di sconto

Acquistando **10** cuspidi ricevi un
corpo punta **extra 80%** di sconto

Corpo punta: TCD 1,5D/3D/5D/8D*
Cuspidi: TCD P/M/K/P2/P+/F

*Esclusi corpi punta 12D e per prefiori di maschiatura



WIN SFEED
ADVANCED MACHINING

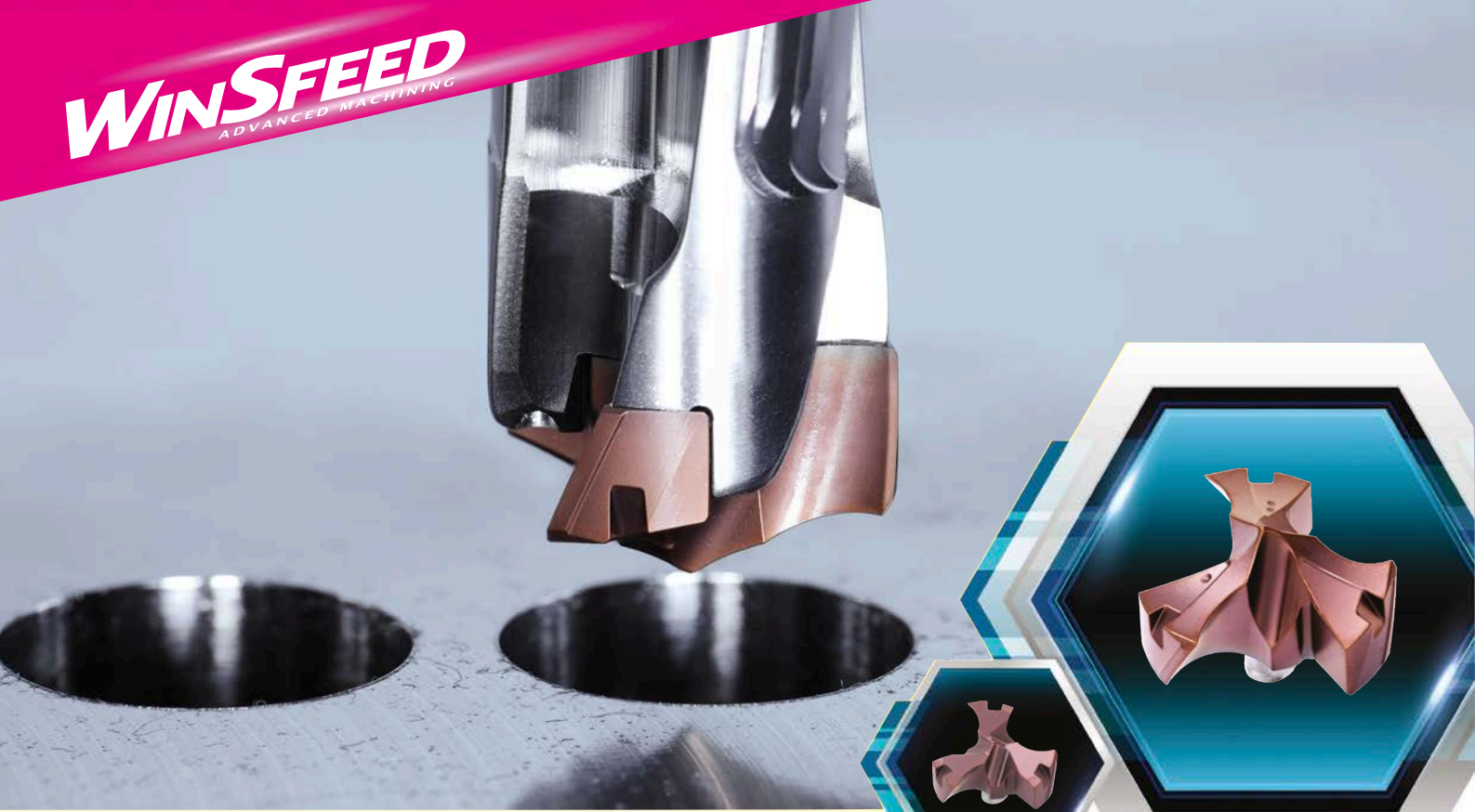

DRILL SFEED
INDEXABLE 3 FLUTE

**Punta a cuspidi a 3 taglienti
per elevata produttività**

Acquistando **6** cuspidi ricevi un
corpo punta **extra 80%** di sconto

Corpo punta: 3ED 3D/5D/8D
Cuspidi: 3ED P+/F

 **TaeguTec**
Member IMC Group



WIN SFEED
ADVANCED MACHINING



SOLID 3 DRILL

3 FLUTE

**Punte in metallo duro a tre taglienti
8xD e con geometria a fondo piatto**

Acquistando **4** punte ricevi
una punta in **omaggio***

Punta: 3HD FI3/FI5/IP8

*Le punte devono avere lo stesso codice



WIN SPEED
ADVANCED MACHINING



WINMILL
ADVANCED MACHINING

Mini inserto per spallamento a 90° e alto avanzamento con sede a V per un migliore bloccaggio

Acquistando **30** inserti ricevi una fresa cilindrica o modulare con **extra 70%** di sconto

Fresa: 2S-TE90CV
Inserti: CV_T05



 **TaeguTec**
Member IMC Group

WIN SPEED
ADVANCED MACHINING



WINMILL
ADVANCED MACHINING

Nuova generazione di inserti per spallamento a 90° con elevata capacità di rampa

Acquistando **30** inserti ricevi
una fresa cilindrica o modulare
con **extra 70%** di sconto

Acquistando **60** inserti ricevi
una fresa a manicotto
con **extra 70%** di sconto

Fresa: TE90AV/TFM90AV*
Inserti: AV_T

*Escluse frese a riccio



 **TaeguTec**
Member IMC Group

WINSPEED
ADVANCED TECHNOLOGY



WIN4FEED

Inserto per alti avanzamenti ad elevato angolo di rampa e con sicuro bloccaggio a 'V'

Acquistando **30** inserti ricevi una fresa cilindrica o modulare con **extra 70%** di sconto

Acquistando **60** inserti ricevi una fresa a manicotto con **extra 70%** di sconto

Fresa: TEBLV/TFMBLV
Inserti: BLMV



WINSPEED
ADVANCED TECHNOLOGY



CHASE 8 MILL

90° FACING & SHOULDERING

Inserto quadro per spallamento a 90° con 8 taglienti economici

Acquistando **30** inserti ricevi
una fresa cilindrica o modulare
con **extra 70%** di sconto

Acquistando **60** inserti ricevi
una fresa a manicotto
con **extra 70%** di sconto

Fresa: 8D-TE90, 8D-TF90*
Inserti: SQ_U 07/10/12

*Fino a Ø125 massimo

 **TaeguTec**
Member IMC Group



WINSPEED
ADVANCED TURNING

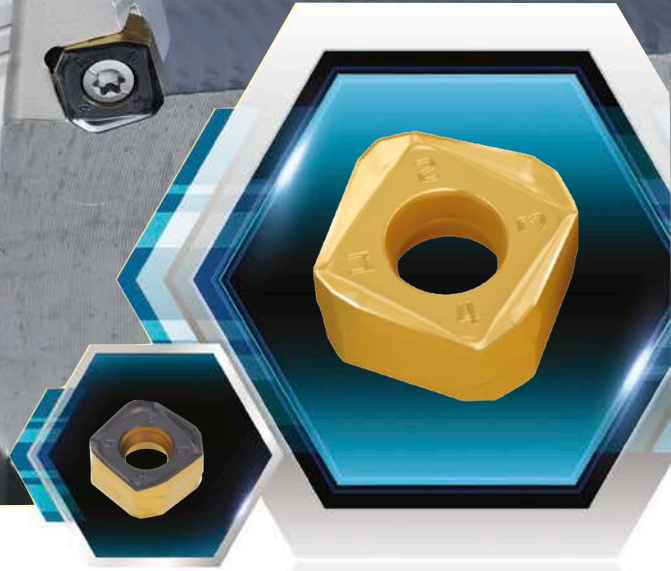

CHASE & SFEED
FACING & HIGH FEED

**Fresa per spianatura e ad alti avanzamenti
con inserto a 8 taglienti per elevata produttività**

Acquistando **60** inserti ricevi
una fresa a manicotto
con **extra 70%** di sconto

Fresa: 8D-TF45, 8D-TF20*
Inserti: SQKU 11/14

*Fino a Ø125 massimo

 **TaeguTec**
Member IMC Group

